

DN65

1200 - 3600 r/min

Ø184

3~ 400 V

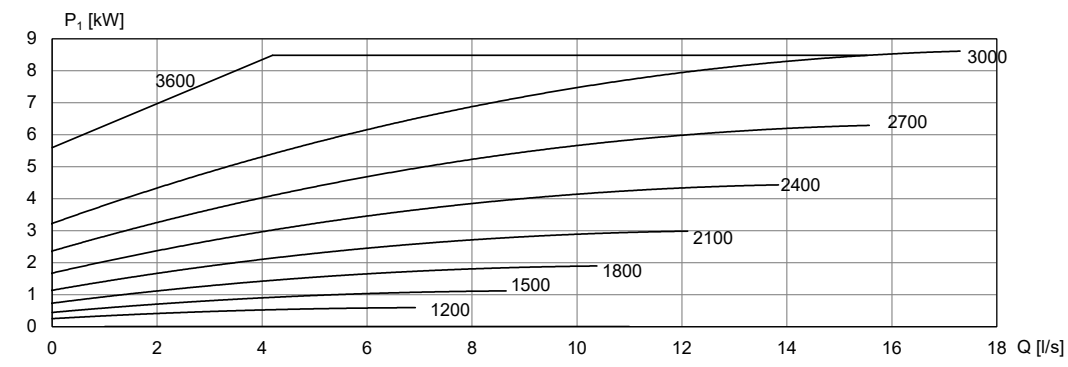
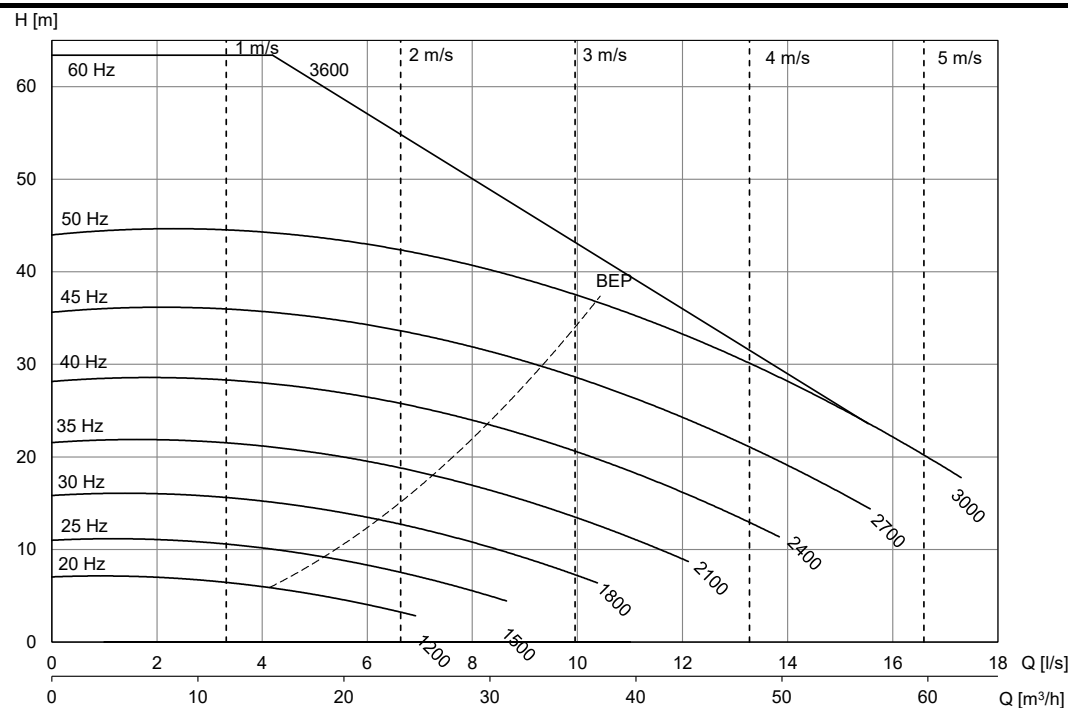
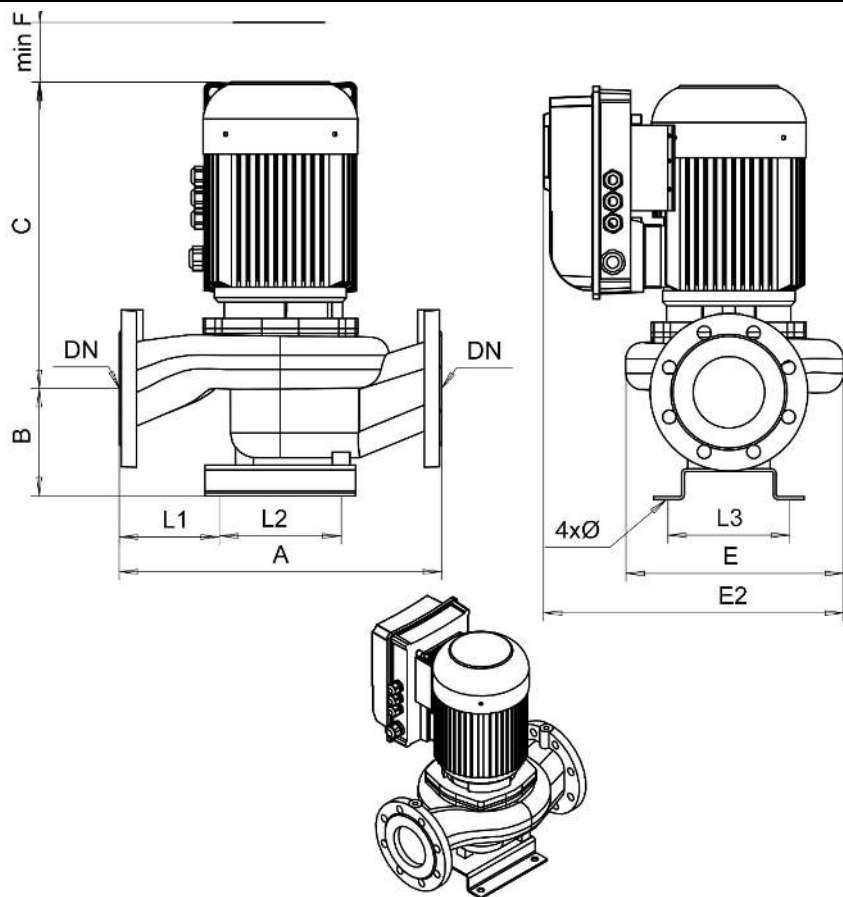

[mm]									
A	B	C	minF	E	E2	L1	L2	L3	Ø
360	125	540	150	255	465	93	170	170	16

Motor	P_{2N} [kW]	I_N [A] (3x400V)	[kg]
KPVS-132 E1 F19	7,5	20,0	102