

DN65

600 - 1800 r/min

Ø188

3~ 400 V

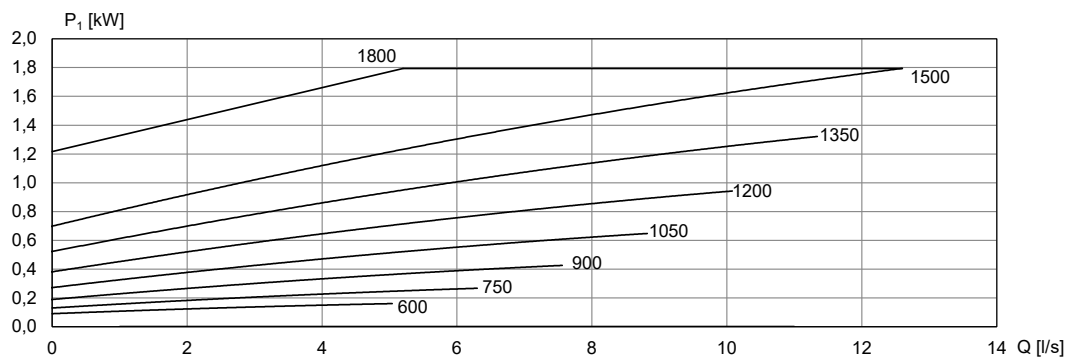
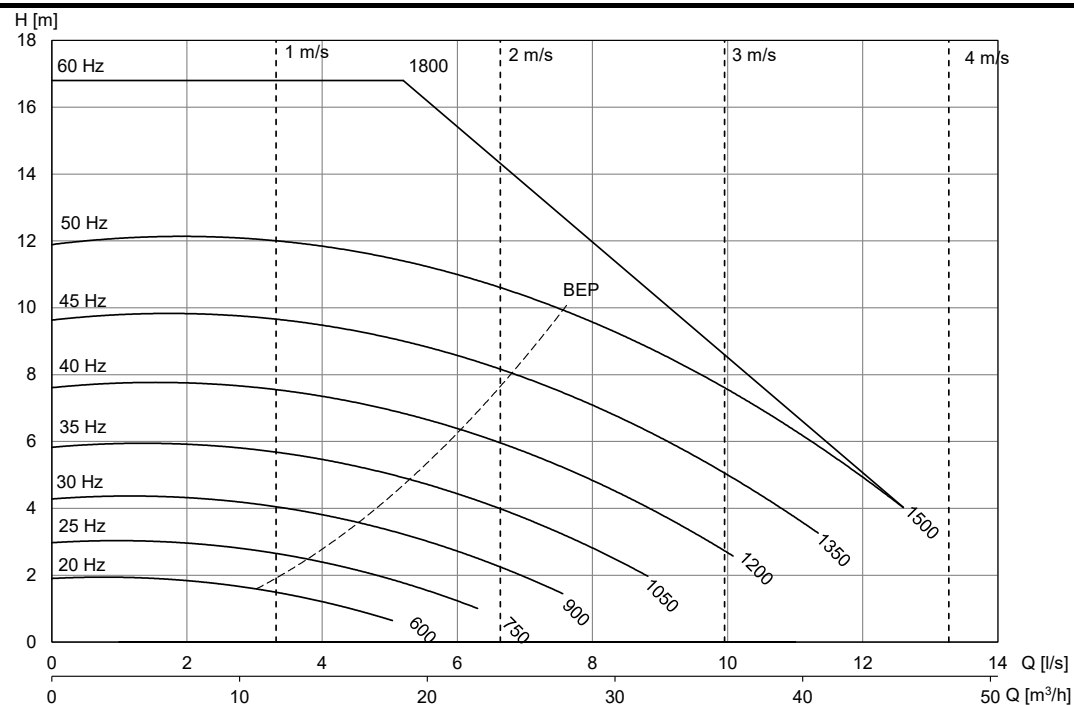
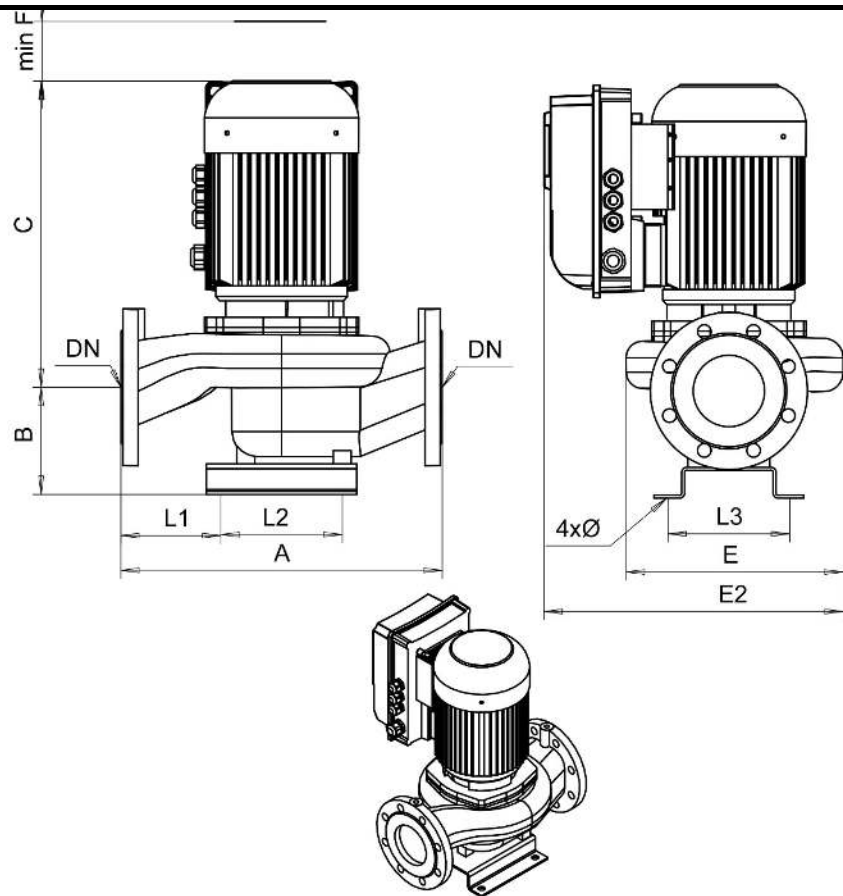

[mm]									
A	B	C	minF	E	E2	L1	L2	L3	Ø
360	125	450	150	255	390	95	170	170	16

Motor	P_{2N} [kW]	I_N [A] (3x400V)	[kg]
KPVS-90-2 F19	1,5	4,0	55