

DN65

600 - 2100 r/min

Ø188

3~ 400 V

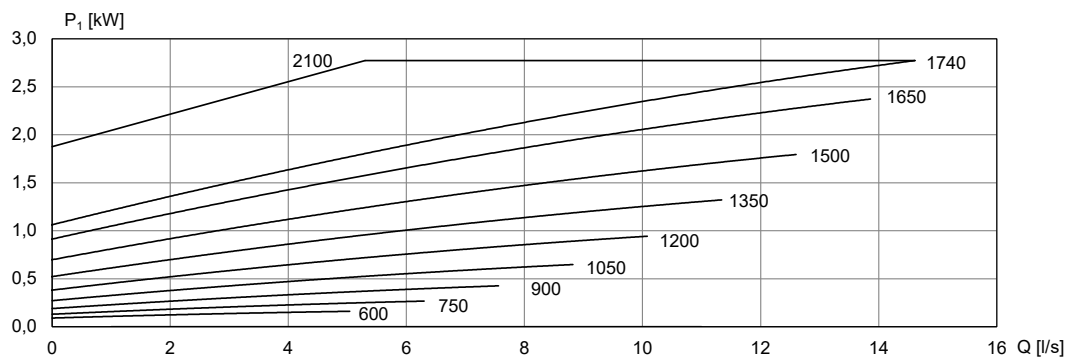
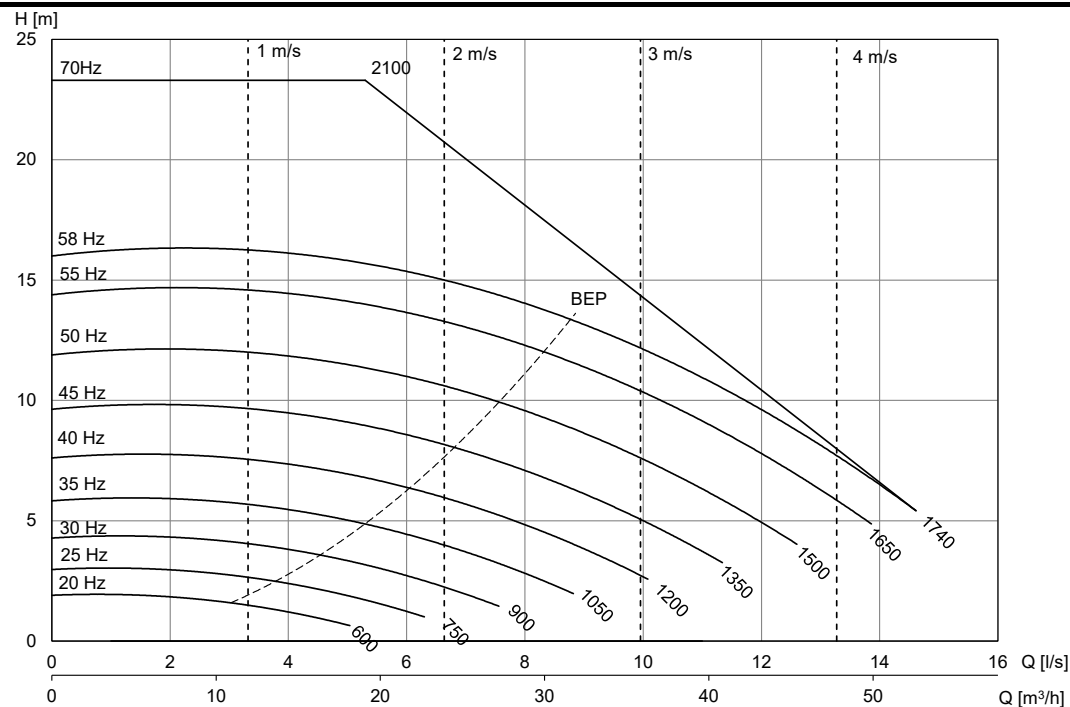
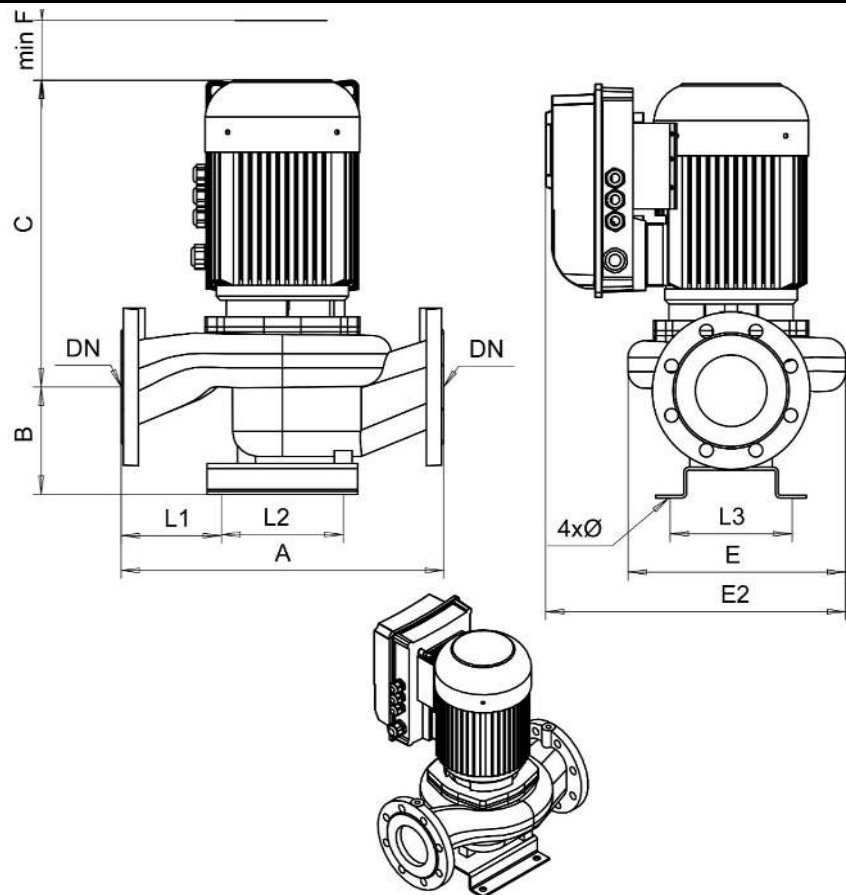

[mm]									
A	B	C	minF	E	E2	L1	L2	L3	Ø
360	125	490	150	255	410	95	170	170	16

Motor	$P_{2N}$ [kW]	$I_N$ [A] (3x400V)	[kg]
KPVS-100-2 F19	2,2	7,30	69