

DN100 1200 - 3300 r/min Ø138 3~ 400 V

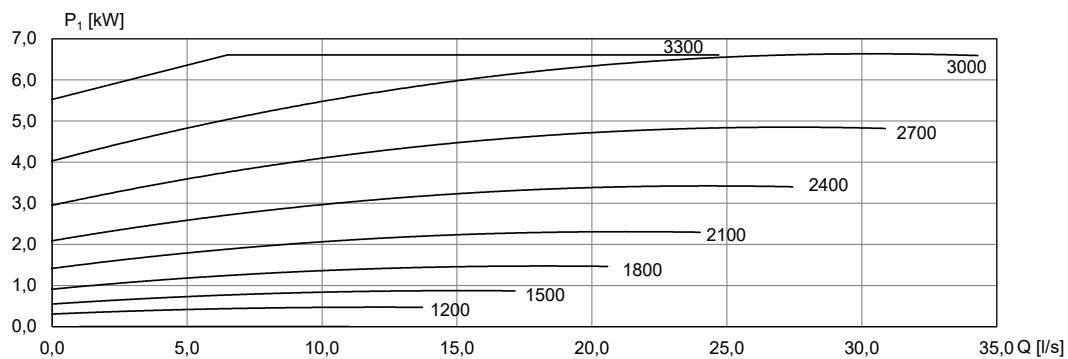
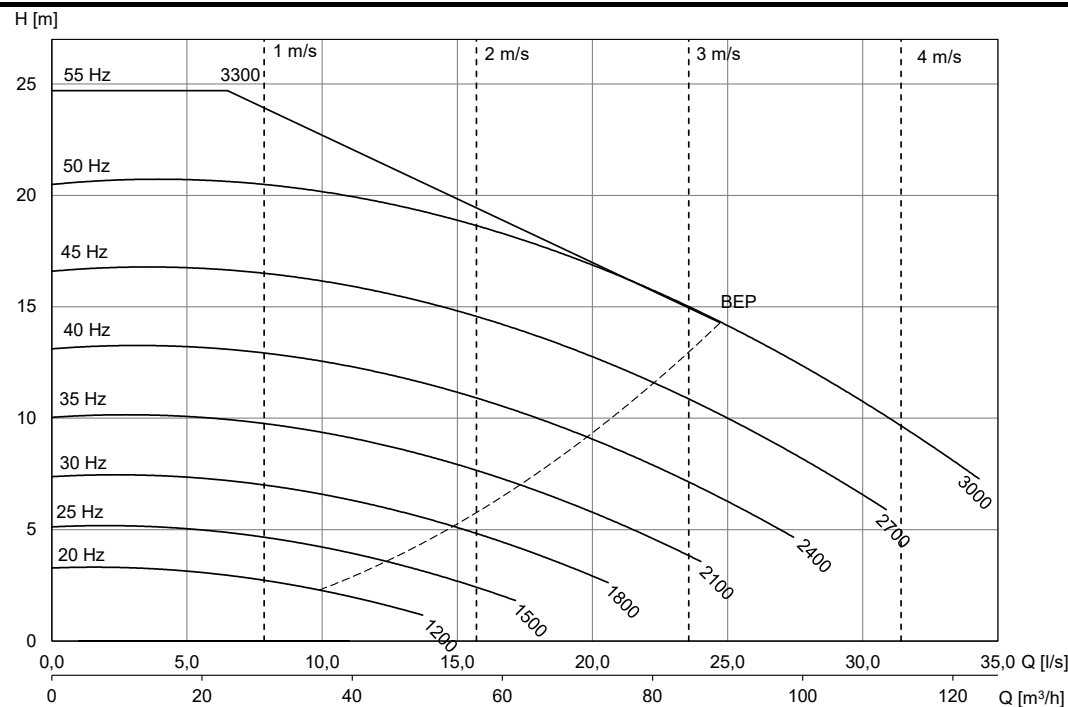
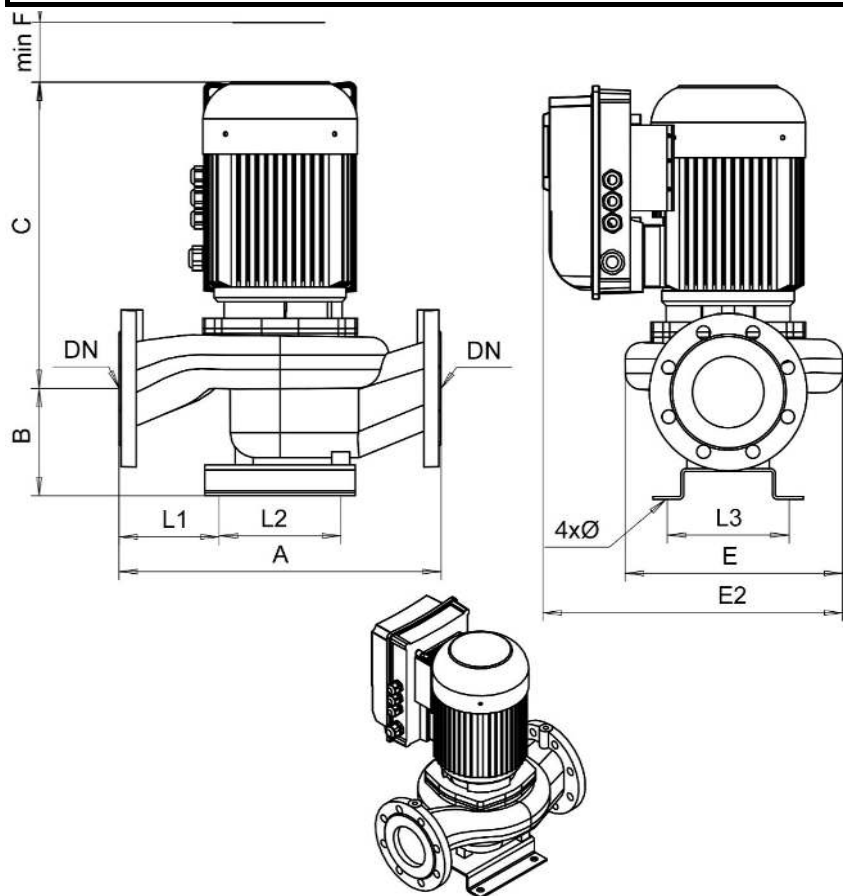

[mm]									
A	B	C	minF	E	E2	L1	L2	L3	Ø
450	150	545	150	300	490	140	170	170	16

Motor	P _{2N} [kW]	I _N [A] (3x400V)	[kg]
KPVS-132 E1 F19	5,5	14,2	114