

G1"

PN10

Version A = Standard

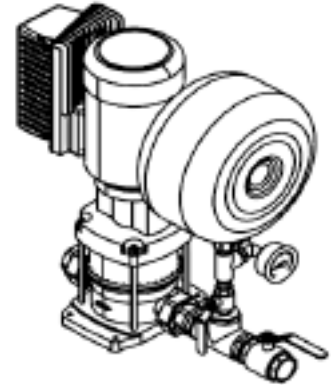
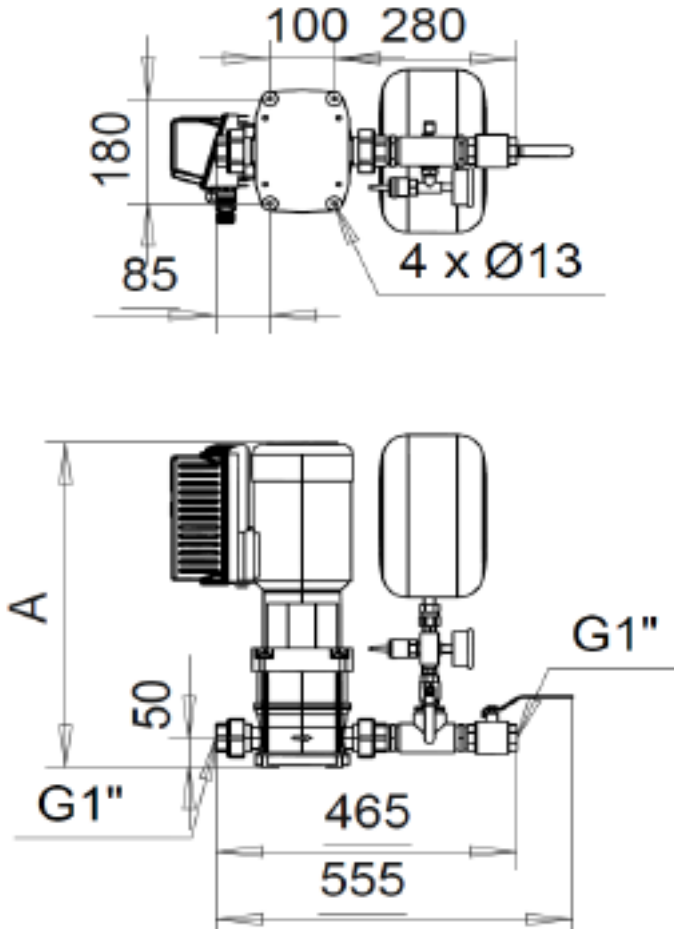

Version B

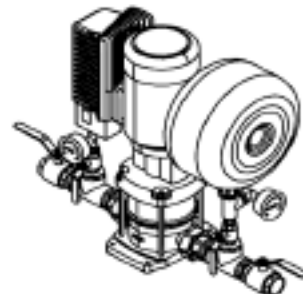
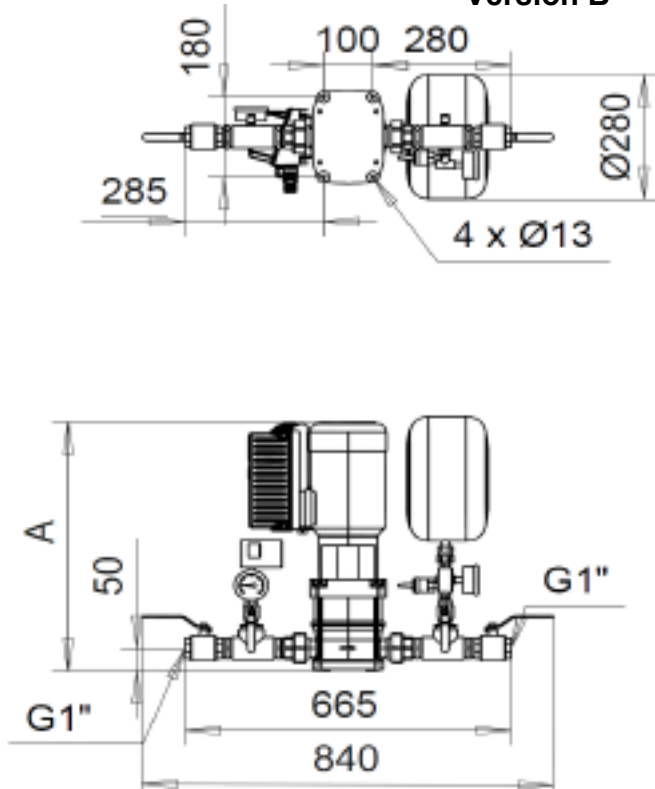

Free space 250 - 300 mm required on the top of the pump

Type	PN [bar]	P _{2,N} [kW]	1x230V I [A]	[kg]	A [mm]
BM 1 -MVVE 6/3 SC	10	0,75	6,1	36	570

