

DN100

600 - 1800 r/min

Ø225

3~ 400 V

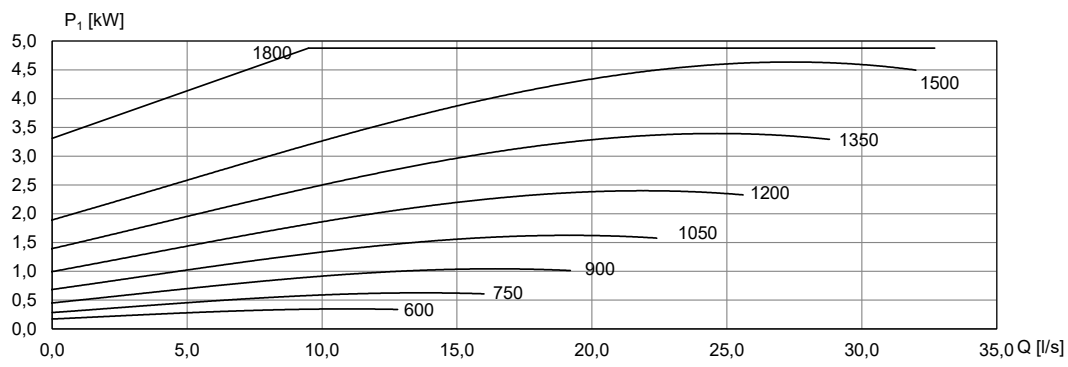
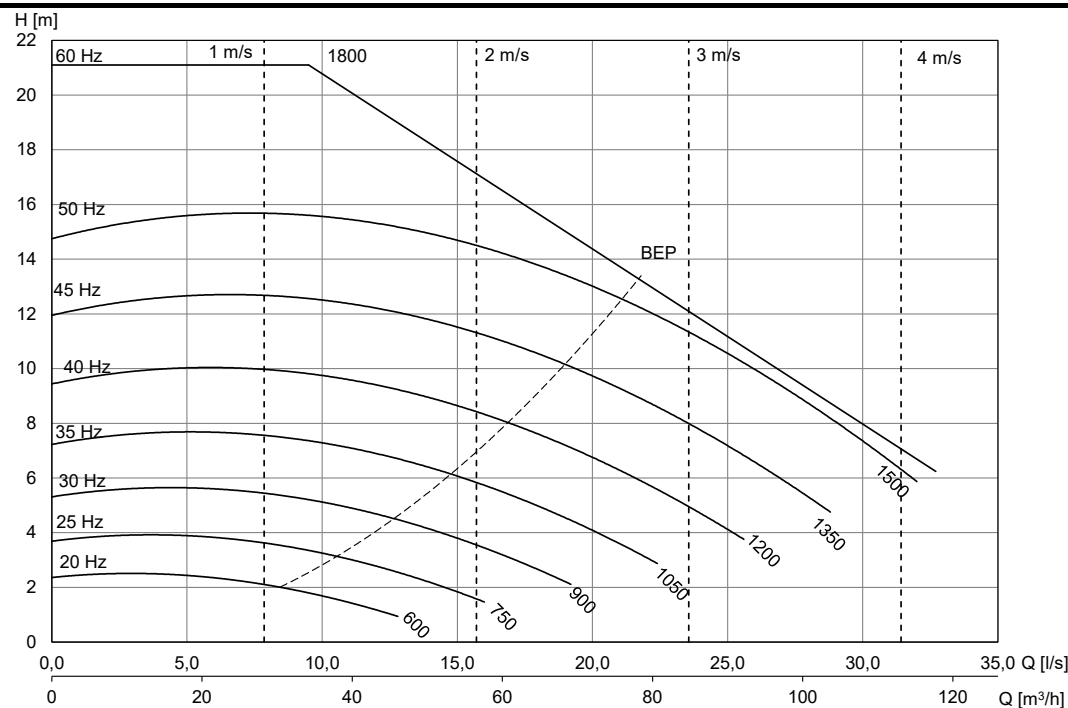
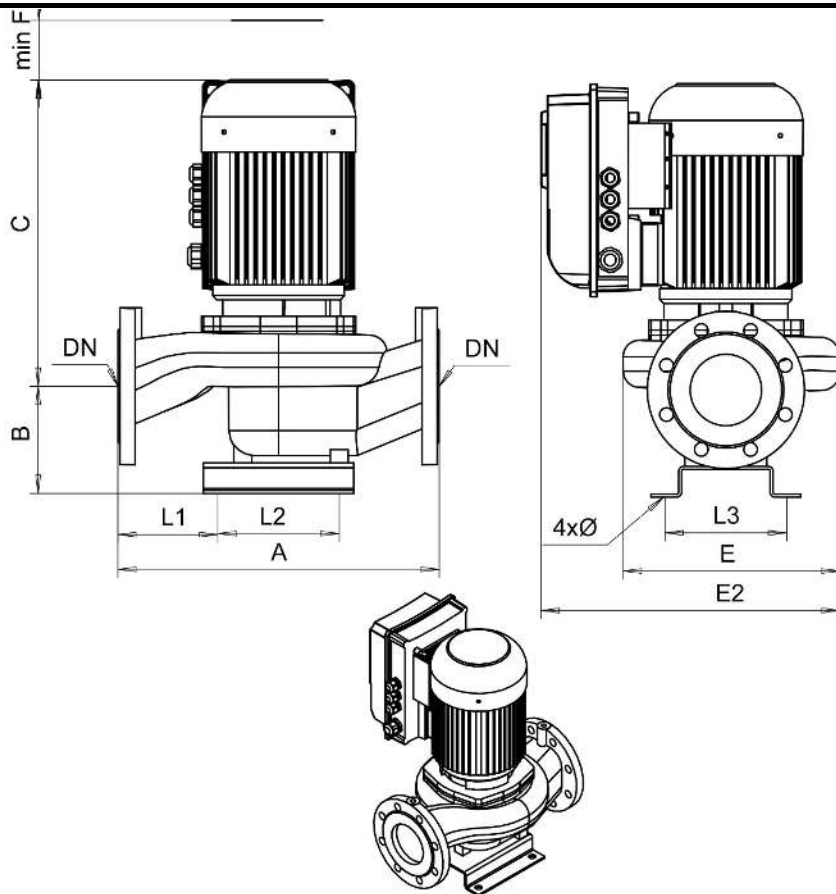

[mm]									
A	B	C	minF	E	E2	L1	L2	L3	Ø
660	173	485	250	445	505	208	290	290	22

Motor	$P_{2N}$ [kW]	$I_N$ [A] (3x400V)	[kg]
KPVS-112-2 F31	4	11,5	165