

SPIROTECH SPECIFICATION SHEET



Product: SpiroCombi Magnet
DN65 Flanged end

Type:
Date:

BC065FM
12/21/2020

Customer:

Project:

Reference:

Design criteria

Medium:	Water / glycol (max 50%)	
Nom. flow velocity:	1.5	m/s
Nom. flow rate:	20.0	m ³ /h
Max. pressure:	10	bar-g
Max. temperature:	110	°C
Δp at nom. flow:	3.0	kPa
Design standard:	EN 13445	

Testing and quality assurance

Test pressure (bar):	7
Test medium:	Air
Test certificate:	no
Design and manufacturing acc. 2014/68/EU:	yes
Material certificates (structural parts):	no
Drawing:	no
Weld procedures:	no
Nondestructive Testing (X-ray: 10%):	no
Notified body inspection:	no

Construction materials

Body:	S235 JR G2 (St.37)
Connections:	S235 JR G2 (St.37)
Fittings:	S235 JR G2 (St.37)
Flanges (EN 1092-1 PN16):	P250GH
Heads:	S235 JR G2 (St.37)
Deaeration cap:	Brass
Valve sealing:	Viton
Float:	PP
Spirotube Tube:	S235 JR G2 (St.37)
Spirotube Wire:	Copper
Spirotube Solder:	Tin(SnCu3)
Paint:	Standard
Color:	Yellow (RAL 1003)
Dry Pocket:	Copper, Brass
Magnet:	Neodymium
Drain valve:	Nickeled brass

Drawing

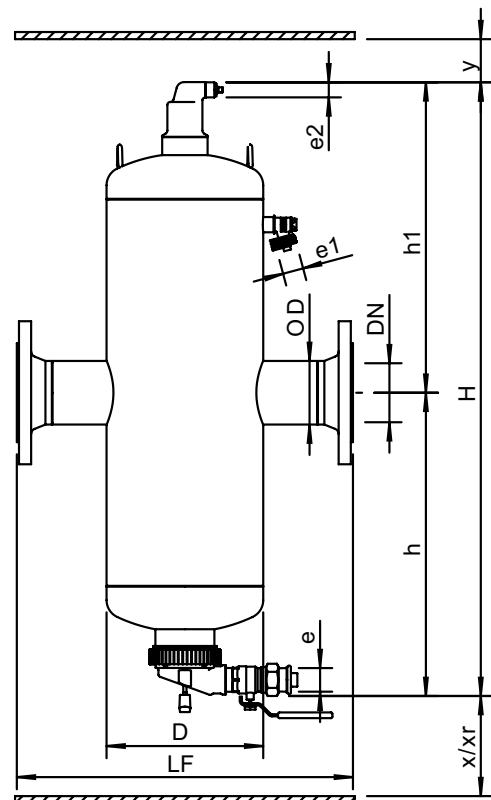

Dimensions

DN:	65
OD:	76.1 mm
H:	712 mm
h:	351 mm
h1:	361 mm
D:	159 mm
LF:	350 mm
e:	Rp1
e1:	G3/4
e2:	R1/2
x:	>75 mm
y:	>50 mm
Xr:	>270 mm

Volume: 5 ltr
Dry weight (approx): 18 kg

Subject to changes